

RockCreeke™



Classic Carriage House Style

RockCreeke gives you time honored styling and wood appearance without the high maintenance associated with a wood door. Your RockCreeke door starts with a high quality insulated steel door and is overlaid with a highly engineered, long-lasting vinyl capstock material, duplicating the appearance of classic wood, without the hassles of wood. With Raynor's ColorWave™ post paint system available, choices are almost endless, giving your home a perfect match with unsurpassed curb appeal. RockCreeke is the perfect balance between unrivaled beauty and enduring quality.

RockCreeke™

Built on a 1 3/8" polyurethane insulated base offering thermal efficiency and maximum structural integrity, RockCreeke is designed to provide unsurpassed character in a maintenance-free design. RockCreeke overlay doors feature an environmentally stable trim board material. With a long-lasting vinyl capstock, this trim board material has an attractive appearance that holds up over time. Best of all, the material technology can utilize "reclaimed" wood fiber and vinyl from post production processes, helping to save natural resources.

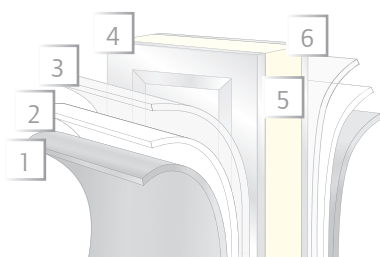

Tested U-Factor	0.20
Calculated R-Value	13.0

1. baked-on finish
2. epoxy primer
3. galvanized layer
4. high-strength steel
5. polyurethane insulation
6. high-strength steel

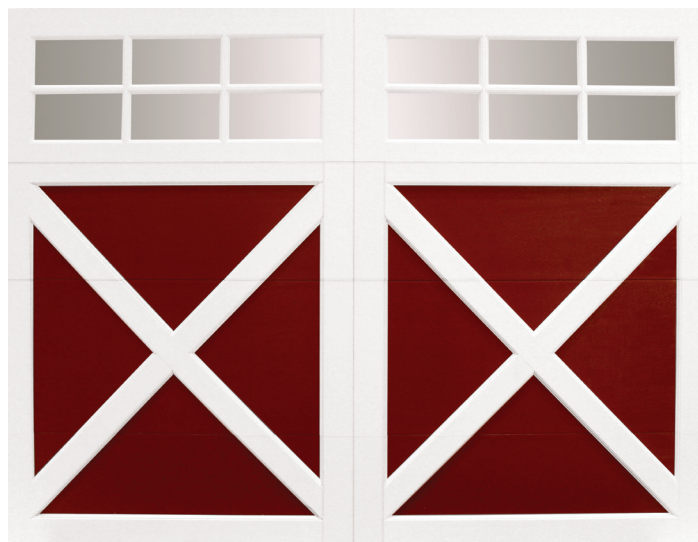

RockCreeke, Swing-Out, White over Barn Red with 3 over 3 clear glass

Pick Your COLORS*

Base Colors

Standard



Optional Using ColorWave™



Board Colors

Standard



Optional



Optional Post Paint Finish**



Raynor's ColorWave™ features Sherwin-Williams® next generation post paint system for your garage door. With 1,500 colors to choose from, home and business owners can couple this elite paint system with state of the art Raynor manufacturing to craft the perfect look for their home or project.

If overlay trim boards are painted, select a color with a Light Reflective Value (LRV) of 50 or higher for doors that receive direct sunlight (east, west or south facing). Refer to the Sherwin-Williams color chart for LRV.

* The swatches shown on monitors and printed materials may vary from the actual color. For a true representation of the color, visit your local Raynor Dealer.

** Not all colors are available in solar reflective paint, colors that are not available as solar reflective cannot be used on polyurethane doors.

Optional DECORATIVE HARDWARE

Raynor's many decorative hardware options add the finishing touches to your RockCreeke™ Door.

Handles

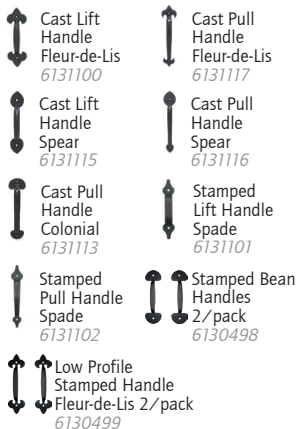

Straps

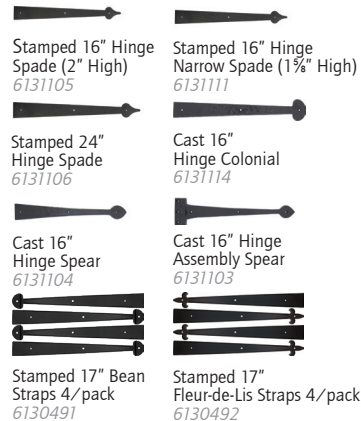

Plastic Decorative Hardware Kit



Screw Applied Colonial Kit
4051105

TRACK/HARDWARE FINISHES



RockCreeke doors are available with a standard galvanized track and hardware system or an EnduraCote™ powder coated track and hardware system. The EnduraCote™ Hardware System features extended-life torsion springs and powder coated hardware. Nylon rollers with steel ball bearings also help to provide superior noise reduction.

Pick Your PANEL

Door styles: Simulated Swing-Out, Bi-fold, and Accordion (12' only)

Sizes:

Heights: up to 10' in 6" increments

Widths: 8'0", 9'0", 10'0", 12'0", 16'0", 18'0"

(Accordion style doors only available in 12' widths)

Swing-Out Single-Car and Double-Car Panel Configurations

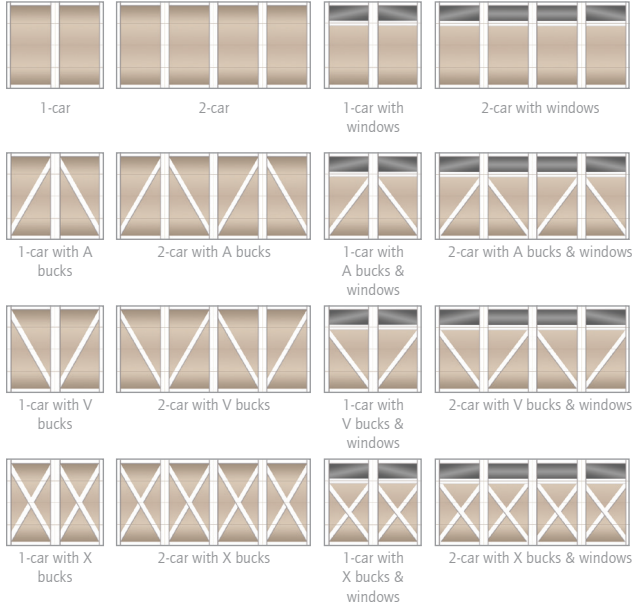

Accordion Panel Configurations (Only Available in 12' widths)

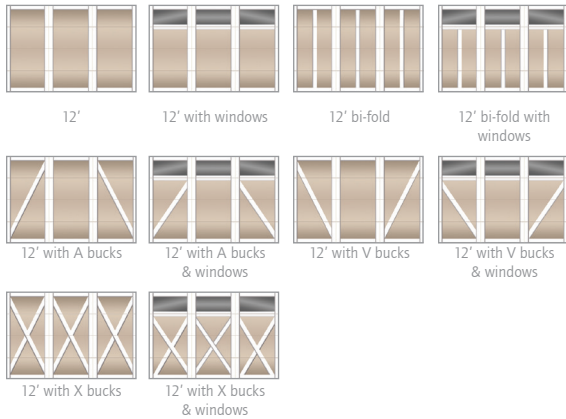

Bi-Fold

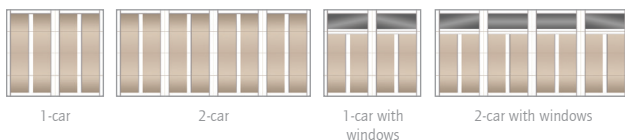

WINDOW Options

RockCreeke's window batters are made from an environmentally stable material that utilizes "reclaimed" wood fiber and vinyl from post-production processes and coated with a long-lasting vinyl capstock, while arches are made from industrial grade polyurethane. Batters and arches are fitted to the window and locked in place, resulting in unprecedented beauty.

Glass Type

Standard:

Clear 1/8" DSB

Optional:

Clear 1/8" Insulated

Rain Glass 3/16"

Rain Glass 3/16" Insulated

Number of Lites

Across

Single Car: 2

12' Accordion: 3

Double Car: 4

Pane Pattern

1-pane, 1-pane arched,

2 over 2

3-pane, 3 over 3,

3 over 3 pane arched,

4-pane, 4 over 4,

4 over 4 pane arched



Our beautiful window designs put the perfect finishing touch on your new Raynor RockCreeke garage door.

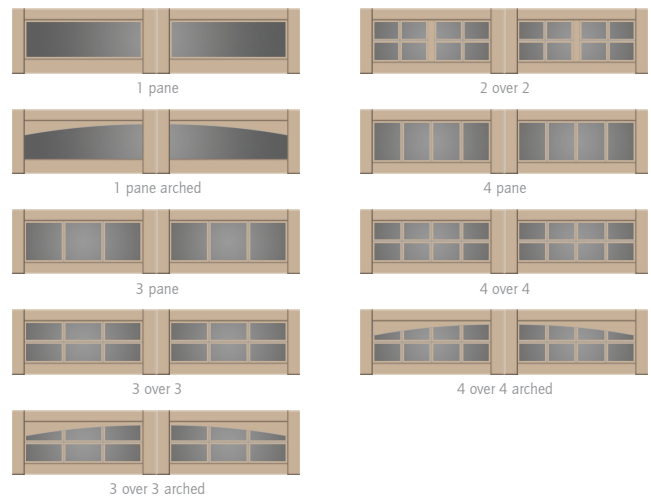

Standard Limited Warranty*

Door Sections

"For As Long As You Own Your Home" against rust

Hardware

EnduraCote: "For As Long As You Own Your Home" against defects in materials and workmanship
Galvanized: 6-years against defects in materials and workmanship

Trim Boards

Delamination: 5-years
Discoloration: 10-years

Springs

EnduraCote: "For As Long As You Own Your Home"
Standard: 3-years against defects in material and workmanship

**Limited Warranty: Visit www.raynor.com/products for complete Limited Warranty details.*



UNSURPASSED CHARACTER IN A MAINTENANCE-FREE DESIGN

The material used in the decorative overlay trim boards is a revolutionary structural composite that blends the very best attributes of vinyl and wood. Its strength and durability have been field-proven in extreme weather and environmental conditions.

Pick your **OPENER**



Sentinel™

Raynor's full line of residential openers offer a broad selection of performance, features and durability. All models offer the ultimate in safety and security features, are available in a variety of horsepower levels and drive systems, as well as wall mounted jackshaft operators and battery backup systems. MyQ™ technology enables you to securely monitor and control your garage door opener with your smart phone, tablet or computer.



DASMA TPV Program

The DASMA Thermal Performance Verification (TPV) Program is a voluntary program to certify and verify the thermal performance ratings of sectional door products using third-party testing and inspection. The U-Factor on this model is verified through the DASMA TPV Program.

Exclusively Distributed by:

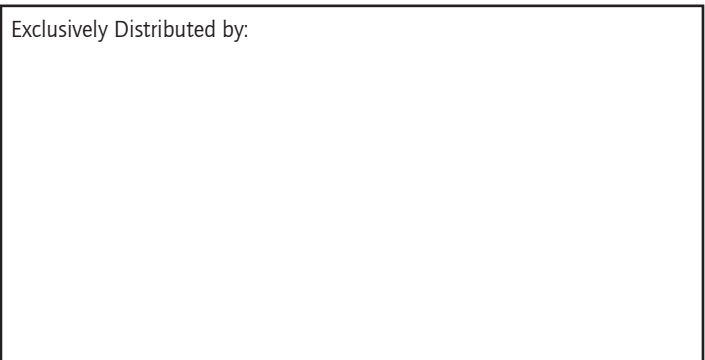

FOLLOW US

